



COVID-19 and Flu A/B Home Test Package Insert

REF L03A-R0645	REF L03A-R0745	English
REF L03A-R0845	REF L03A-R0945	

A rapid test for the detection and differentiation of SARS-CoV-2, Influenza A, and/or Influenza B antigens in anterior nasal specimens. For *in vitro* diagnostic use only. For use under Emergency Use Authorization (EUA) only.

INTENDED USE

The Flowflex Plus COVID-19 and Flu A/B Home Test is a lateral flow immunoassay intended for the qualitative detection and differentiation of SARS-CoV-2, influenza A, and influenza B protein antigens.

This test is authorized for non-prescription home use with self-collected anterior nares nasal swab specimens from individuals aged 14 years or older, or with adult-collected anterior nasal swab specimens from individuals two (2) years or older.

This test is only authorized for individuals with sign and symptoms of respiratory infection consistent with COVID-19 within the first six (6) days of symptom onset when tested at least twice over three days with at least 48 hours between tests.

Clinical signs and symptoms of respiratory viral infection due to SARS-CoV-2 and influenza can be similar.

Results are for the simultaneous identification of SARS-CoV-2, influenza A virus, and influenza B virus protein antigens, but do not differentiate between SARS-CoV and SARS-CoV-2 viruses and are not intended to detect influenza C antigens.

The viral antigens targeted by this test are generally detectable from specimens collected using nasal swabs during the acute phase of infection. Positive results indicate the presence of viral antigens, but the clinical correlation with patient history and other diagnostic information is necessary to determine infection status.

Positive results do not rule out bacterial infection or co-infection with other viruses. The agent detected may not be the definitive cause of the disease. Individuals who test positive with the Flowflex Plus COVID-19 and Flu A/B Home Test should self-isolate and seek follow up care with their physician or healthcare provider as additional testing may be necessary.

All negative results are presumptive and confirmation with a molecular assay, if necessary for patient management, may be performed. Negative results do not rule out SARS-CoV-2, influenza A, and influenza B infection and should not be used as the sole basis for treatment or patient management decisions, including infection control decisions such as isolating from others and wearing masks. Negative results should be considered in the context of an individual's recent exposures, history, and the presence of clinical signs and symptoms consistent with SARS-CoV-2, influenza A, and influenza B infection.

Individuals who test negative and continue to experience SARS-CoV-2 and/or influenza-like symptoms of fever, cough and/or shortness of breath may still have SARS-CoV-2 and/or influenza infection and should seek follow up care with their physician or healthcare provider. The Flowflex Plus COVID-19 and Flu A/B Home Test is only for use under the Food and Drug Administration's Emergency Use Authorization.

SUMMARY AND EXPLANATION

The novel coronaviruses belong to the β genus. COVID-19 is an acute respiratory infectious disease. People are generally susceptible. Currently, the patients infected by the novel coronavirus are the main source of infection; asymptomatic infected people can also be an infectious source. Based on the current epidemiological investigation, the incubation period is 1 to 14 days, mostly 3 to 7 days. The main manifestations include fever, fatigue and dry cough. Nasal congestion, runny nose, sore throat, myalgia and diarrhea are found in a few cases.

Influenza (Flu) is an acute respiratory disease caused by Flu viruses (type A, type B and type C), which is highly infectious and has a short window period. Flu A and B viruses circulate and cause seasonal epidemics of disease. Flu A virus poses a greater risk as compared to Flu B virus. Based on the current epidemiological investigation, the incubation period is generally 1 to 7 days, most of which are 2 to 4 days. Flu patients usually have symptoms of high fever, headache, muscle pain and fatigue, accompanied by respiratory symptoms, such as sore throat, cough, and sputum. The disease is self-limiting, but infants, the elderly, and patients with underlying cardiopulmonary diseases are prone to severe complications such as pneumonia that can lead to death.

PRINCIPLE

The Flowflex Plus COVID-19 and Flu A/B Home Test is a qualitative membrane based chromatographic immunoassay for the qualitative detection and differentiation of the nucleocapsid protein antigens from SARS-CoV-2, Influenza A, and/or Influenza B in human anterior nasal swab specimens.

When specimens are processed and added to the test cassette, SARS-CoV-2 or Flu A/B antigens, if present in the specimen, will react with the colored anti-SARS-CoV-2 or Flu A/B antibody-coated particles, which have been pre-coated on the test strip. The antigen-antibody complex then migrates toward the membrane by capillary action. This complex is then captured by anti-SARS-CoV-2 or anti-Flu A/B monoclonal antibodies immobilized at the related test line region, and a colored line appears on the membrane.

Test results are interpreted visually at 15-30 minutes based on the presence or absence of visually colored lines.

To serve as a procedure control, a red or pink line will always appear in the control line region after proper volume of specimen has been added, and membrane wicking has occurred.

REAGENTS AND MATERIALS

Materials Provided

Kit Component	Quantity	Description
Test Cassettes	1, 2, 5 or 25 individually wrapped for single use	Foil pouched test cassette containing one reactive strip pre-coated with monoclonal anti-SARS and anti-Flu A/B antibodies.
Extraction Buffer	1, 2, 5 or 25 single use buffer tubes, each with an integral dispensing tip	Detergent solution with 0.02% ProClin 300
Nasal Swabs	1, 2, 5 or 25 sterile swabs, single use specimen sampling swabs	For sample collection and transfer
Tube Holder	Only for 25 test quantity	Each holder has capacity for 10 extraction buffer tubes
Quick Reference Instructions	1 English QRI 1 Spanish QRI	

Materials Required But Not Provided

- Timer

REAGENT STORAGE

- The kit can be stored at temperatures between 2-30°C (36-86°F).
- The test must remain in the sealed pouch until use and should be run at temperatures between 15-30°C (59-86°F) and in environments with good lighting.
- The test is stable until the expiration date printed on the sealed pouch.
- The test must remain in the sealed pouch until use.
- DO NOT FREEZE.
- Do not use after the expiration date.

QUALITY CONTROL

Internal procedural controls are included in the test. A red or pink line appearing in the control line region (Ctl) is an internal procedural control. The appearance of the procedural control line indicates that proper volume of specimen has been added and capillary flow occurred. If the procedural control line does not develop in 15 minutes, the test result is considered invalid, and retesting with a new cassette is recommended.

WARNINGS AND PRECAUTIONS

- Read the instructions fully and carefully before performing the test. Failure to follow the instructions may result in inaccurate test results.
- This test may only be used in symptomatic individuals.
- In the USA, this product has not been FDA cleared or approved, but has been authorized by FDA under an Emergency Use Authorization. This product has been authorized only for the detection of proteins from SARS-CoV-2, influenza A, and influenza B, not for any other viruses or pathogens. The emergency use of this product is only authorized for the duration of the declaration that circumstances exist justifying the authorization of emergency use of in vitro diagnostics for detection and/or diagnosis of COVID-19 under Section 564(b)(1) of the Federal Food, Drug, and Cosmetic Act, 21 U.S.C. § 360bbb-3(b)(1), unless the declaration is terminated or authorization is revoked sooner.
- **Serial testing should be performed in symptomatic individuals with SARS-CoV-2 negative results at least twice over three days (with 48 hours between tests). You may need to purchase additional tests to perform this serial (repeat) testing.**
- **Consistent with serial testing recommendations for SARS-CoV-2, for multi-analyte tests, symptomatic individuals who test positive for influenza A or B on the initial test but test negative for SARS-CoV-2 should be tested again in 48 hours to evaluate for co-infection with SARS-CoV-2 infection.**
- This test is read visually. Individuals with impaired vision or color-impaired vision should seek help in interpretation of their test results.
- Do not use the test after the expiration date shown on the test cassette pouch or if the test kit contents are damaged or opened.
- Wear a safety mask or other face-covering when collecting a specimen from a child or another individual.
- Do not use on anyone under 2 years of age.
- The swab specimen should be processed and tested immediately after collection.
- Leave the test cassette sealed in its pouch until just before use.
- Once opened, the test cassette should be used within 60 minutes to prevent false test results.
- Do not use nasal sprays for at least 30 minutes before collecting a nasal sample as this may lead to incorrect results.
- Follow the instruction carefully; false negative test results may occur if a specimen is incorrectly collected or handled.
- **Do not read test results before 15 minutes or after 30 minutes. Results read before 15 minutes or after 30 minutes may lead to a false positive, false negative, or invalid result.**
- Test components are single-use. Do not re-use the test cassette, buffer liquid, or swab.

- Keep testing kit and components away from children and pets before and after use. Avoid contact with your skin, eyes, nose, and mouth. Do not ingest any kit components as the reagent solution contains harmful chemicals (see table below).
- If the reagent solution contacts the skin, eyes, nose, or mouth, flush with large amounts of water.

If irritation persists, seek medical advice:

<https://www.poisonhelp.org> or 1-800-222-1222

Hazardous Ingredients for the Reagent Solution			
Hazard Category (mixture)	GHS Hazard Statement for mixture	Labeling of Harm(s)	Hazardous Ingredients (%)
2	Skin irritation	Causes skin irritation (H315)	<ul style="list-style-type: none"> • Proclin 300 / 0.02% • Tris / 1%
2	Eye irritation	Causes eye irritation (H320)	<ul style="list-style-type: none"> • Proclin 300 / 0.02% • Tris / 1%

- For more information on EUAs please visit: <https://www.fda.gov/emergency-preparedness-and-response/mcm-legal-regulatory-and-policy-framework/emergency-use-authorization>
- For the most up to date information on COVID-19, please visit: www.cdc.gov/COVID19

PREPARATION

1. Wash or sanitize hands. Dry hands before testing.

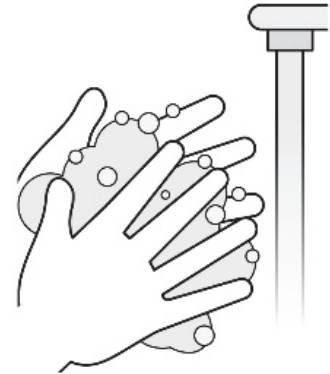

2. Remove the test cassette from pouch and lay on a clean, flat surface. Locate the Result Window and Sample Well on the cassette.

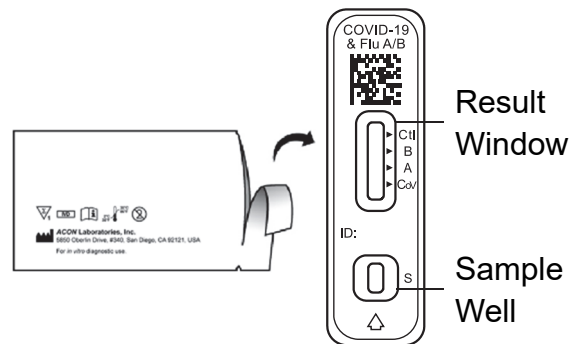

3. Remove buffer tube from pouch. Remove the foil from tube.

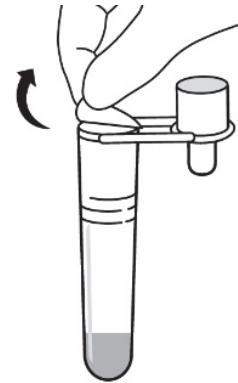

4. Punch through perforation on box to form a tube holder. Place tube in holder.

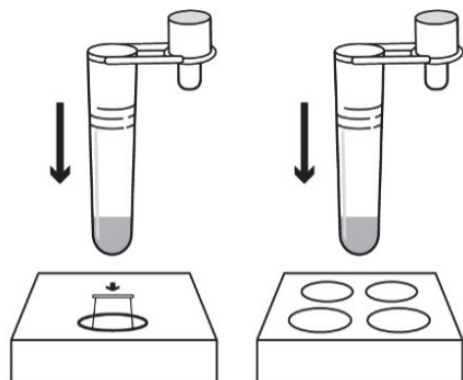

TEST PROCEDURE

1. Open swab package at stick end. Take out swab. **Do not touch the swab tip.**

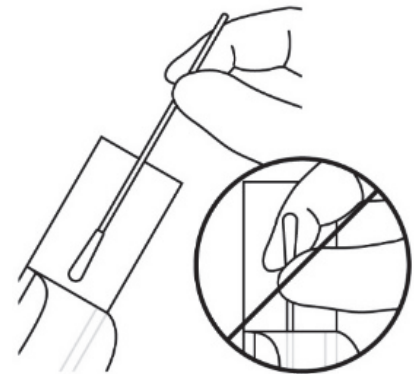

2. Gently insert tip of swab into 1 nostril ($\frac{1}{2}$ to $\frac{3}{4}$ of an inch). **With children, insert swab less than $\frac{3}{4}$ of an inch.** You may need to have a second person to hold the child's head while swabbing. **Firmly rub swab** in a circular motion against the inside wall of nostril **5 times** (15 sec.). Repeat this in the other nostril using the same swab. Please use a face mask when swabbing others.

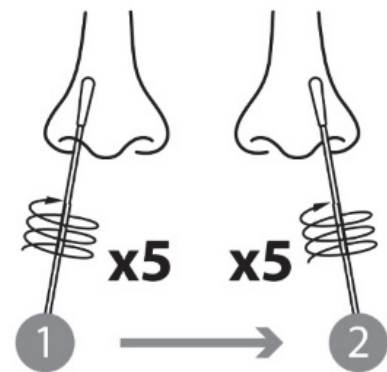

3. Remove the swab from nostril and immediately place into buffer tube. Swirl swab in buffer tube for 30 seconds.

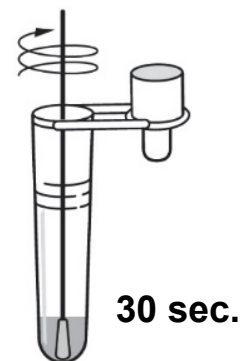

4. Rotate swab 5 times while **squeezing tube**. Incorrect results may be observed if the swab is not swirled for 30 seconds or rotated 5 times.

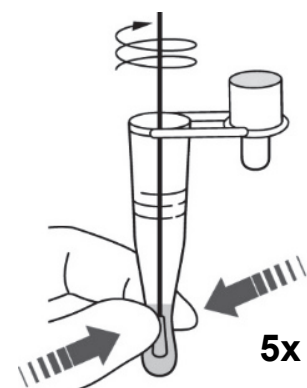

5. Remove swab **while squeezing tube**. Discard swab.

Note: Swab with collected sample should be tested no more than 30 minutes after adding to the tube.

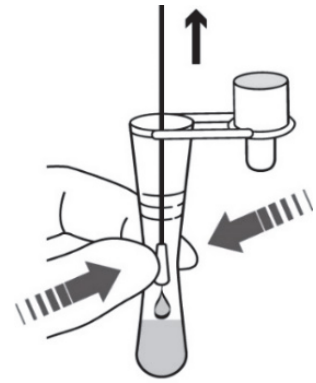

6. Attach dropper tip and mix by swirling or flicking bottom of tube.

Note: A false negative result may occur if the swab is not swirled at least 30 seconds or rotated 5 times.

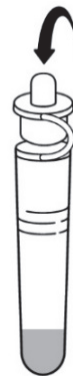

7. Invert the buffer tube and gently squeeze **4 drops** of sample into Sample Well. Discard tube.

Note: An invalid or false negative result may occur if less than 3 drops or more than 6 drops of fluid are added to the Sample Well.



8. Set timer and read result after 15 minutes. Do not read after 30 minutes. Discard test cassette.

Note: A false negative or false positive result may occur if the test result is read before 15 minutes or after 30 minutes.



15 min

RESULT INTERPRETATION

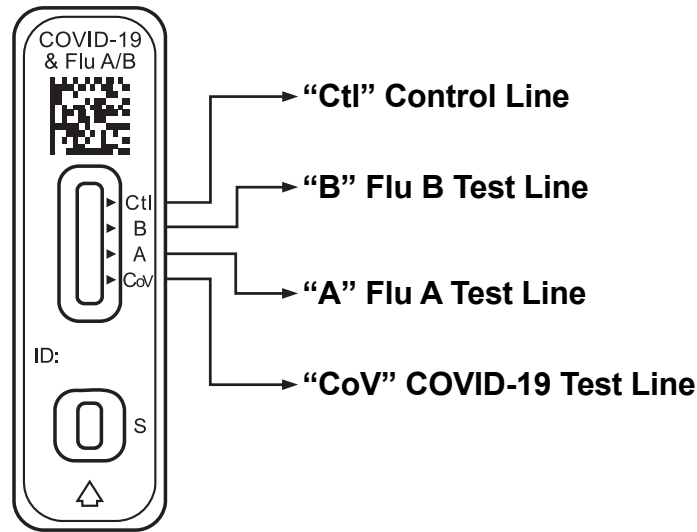

Note: Any visible faint red or pink line in the Test line region (CoV/A/B) should be read as positive. If there is no colored line in the Test line region (CoV, A, and/or B) and a colored line in the Control line (Ctl) region, then that test line (CoV, A, and/or B) should be read as negative.

POSITIVE

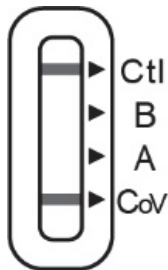

COVID-19 Positive

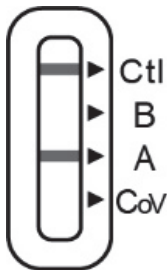

Flu A Positive



Flu B Positive

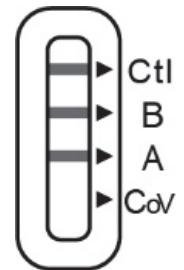

Flu A + Flu B Positive

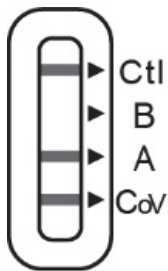

COVID-19 + Flu A Positive

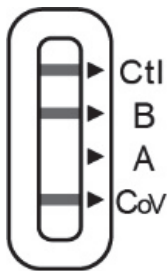

COVID-19 + Flu B Positive



COVID-19, Flu A + Flu B Positive

If the Control (Ctl) line is visible and any other line or multiple lines, no matter how faint, at “CoV”, “A” and/or “B” appear, the test is positive for that virus. Repeat testing is needed for all samples that are negative for COVID-19 on the first day of testing, even if they are positive for Flu A and/or B (see SERIAL TESTING section).

The COVID-19, Flu A and/or Flu B virus(es) were detected in your sample. It is very likely that you have the respective infection(s) and are contagious. Please contact your healthcare provider or your local health authorities and follow local guidelines for self-isolation. There is a small chance that this test can give you a positive result that is incorrect (a false positive).

NEGATIVE

If the Control (Ctl) line is visible, but the Test (CoV/A/B) line is not visible, the test is negative. The COVID-19, Flu A, or Flu B virus have not been detected.

To increase the chance that the negative result for COVID-19 is accurate, you should test again in 48 hours after the first day of testing.

If respiratory symptoms persist, seek follow-up care with a healthcare provider.

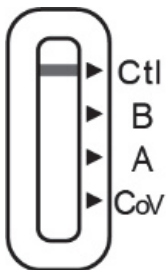

The virus from COVID-19, Flu A, and/or Flu B were not detected in the sample. A negative result does not mean it is certain that you do not have COVID-19, Flu A and/or Flu B infection. There is a higher chance of false negative results with antigen tests compared to laboratory-based molecular tests. If you tested negative and continue to experience COVID-19, Flu A and/or Flu B-like symptoms, you should seek follow-up care with your healthcare provider.

All negative results should be treated as presumptive and confirmation with a molecular assay may be necessary if there is a high likelihood of SARS-CoV-2 infection, such as in an individual with a close contact with COVID-19 or with suspected exposure to COVID-19 or in communities with high prevalence of infection. Negative results do not rule out SARS-CoV-2 infection and should not be used as the sole basis for treatment or patient management decisions, including infection control decisions.

INVALID

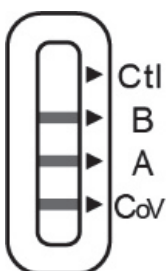

If the Control (Ctl) line is not visible, even if any other line is visible in the result window, the test is not valid. Re-test with a new swab and a new test cassette.

If the problem persists, call (800) 838-9502 for assistance.

RESULTS REPORTING

Report your test result(s) at [MakeMyTestCount.org](https://www.makemytestcount.org)-this voluntary and anonymous reporting helps public health teams understand COVID-19 spread in your area and across the country and informs public health decisions.

SERIAL TESTING

Serial (repeat) testing is needed for all samples that are negative for SARS-CoV-2 on the first day of testing, even if they are positive for influenza A and/or B. Repeat testing is needed to improve test accuracy for SARS-CoV-2. Please follow the table below when interpreting test results. Serial testing does not need to be performed if patients have a positive SARS-CoV-2 result on the first day of testing.

Status on First Day of Testing: With Symptoms			
Day 0 (First Test)	Serial Testing?	Day 2 (Second Test)	Interpretation
SARS-CoV-2 (+), Influenza A and/or B (-)	NO	Not Needed	Positive for COVID-19, Presumptive Negative for Influenza
SARS-CoV-2 (+), Influenza A and/or B (+)	NO	Not Needed	Positive for COVID-19, Positive for Influenza A and/or B
SARS-CoV-2 (-), Influenza A and/or B (-)	YES	SARS-CoV-2 (+), Influenza A and/or B (-)	Positive for COVID-19, Presumptive Negative for Influenza
SARS-CoV-2 (-), Influenza A and/or B (+)	YES	SARS-CoV-2 (+), Influenza A and/or B (+)	Positive for COVID-19, Positive for Influenza A and/or B
SARS-CoV-2 (-), Influenza A and/or B (-)	YES	SARS-CoV-2 (-), Influenza A and/or B (+)	Presumptive Negative for COVID-19, Positive for Influenza A and/or B
SARS-CoV-2 (-), Influenza A and/or B (-)	YES	SARS-CoV-2 (-), Influenza A and/or B (-)	Presumptive Negative for COVID-19, Presumptive Negative for Influenza
SARS-CoV-2 (-), Influenza A and/or B (-)	YES	SARS-CoV-2 (+), Influenza A and/or B (+)	Positive for COVID-19, Positive for Influenza A and/or B
SARS-CoV-2 (-), Influenza A and/or B (+)	YES	SARS-CoV-2 (-), Influenza A and/or B (-)	Presumptive Negative for COVID-19, Positive for Influenza A and/or B
SARS-CoV-2 (-), Influenza A and/or B (+)	YES	SARS-CoV-2 (-), Influenza A and/or B (+)	Presumptive Negative for COVID-19, Positive for Influenza A and/or B
SARS-CoV-2 (-), Influenza A and/or B (+)	YES	SARS-CoV-2 (+), Influenza A and/or B (+)	Positive for COVID-19, Positive for Influenza A and/or B

LIMITATIONS

1. The performance of this test was established based on the evaluation of a limited number of clinical specimens collected between December 2022 and March 2024. The clinical performance has not been established for all circulating variants but is anticipated to be reflective of the prevalent variants in circulation at the time and location of the clinical evaluation. Performance at the time of testing may vary depending on the variants circulating, including newly emerging strains of SARS-CoV-2 and their prevalence, which change over time.
2. There is a higher chance of false negative results with antigen tests than with laboratory-based molecular tests due to the sensitivity of the test technology. This means that there is a higher chance this test will give a false negative result in an individual with COVID-19 and influenza as compared to a molecular test, especially in samples with low viral load.
3. All negative results with this test are presumptive and confirmation with a molecular assay may be necessary.
4. Incorrect test results may occur if a specimen is incorrectly collected or handled.
5. If you continue to have symptoms consistent with COVID-19 and influenza, and both your first and second tests are negative, you may not have COVID-19 or influenza, however you should follow-up with a healthcare provider.
6. If your test is positive, then proteins from the viruses that cause COVID-19 or influenza have been found in the sample and the individual likely has respiratory infection with SARS-CoV-2 or influenza.
7. Individuals who recently received nasally administered influenza A or influenza B vaccine may have false positive test results after vaccination.
8. This test is read visually and has not been validated for use by those with impaired vision or color-impaired vision.

PERFORMANCE CHARACTERISTICS

Clinical Sensitivity, Specificity and Accuracy

The performance of Flowflex Plus COVID-19 and Flu A/B Home Test was established in a prospective all-comers clinical study conducted between December 2022 and March 2024. 741 anterior nasal swabs were evaluated in symptomatic individuals with respiratory symptoms within 6 days of symptom onset and were either self-collected and tested by users >14 years of age or collected and tested by an adult from users who were < 14 years of age. The study was conducted in a simulated home setting environment at ten study sites in the U.S. All adults and all minors \geq 14 years of age performed the test unassisted and interpreted the result, using only the Quick Reference Instructions. The investigational sample was collected after the collection of the nasopharyngeal swab for comparator testing. The Flowflex Plus COVID-19 and Flu A/B Home Test Home Test results were compared to FDA EUA and 510(k) RT-PCR COVID-19 molecular assays to determine test performance in the tables below:

Table 1. Subject Demographics

Factor	Lay user collecting and testing (N=153)	Self-collecting and testing (N=588)	Overall (N=741)
Age			
Mean (SD)	7.3 (3.2)	44.6 (17.9)	36.9 (22.0)
Median [Min, Max]	7 [2, 13]	44 [14, 91]	36 [2, 91]
Age Group			
≥ 2 - <14 years of age	153 (100%)	0 (0%)	153 (20.6%)
14-24 years of age	0 (0%)	88 (15%)	88 (11.9%)
25-64 years of age	0 (0%)	407 (69%)	407 (54.9%)
≥ 65 years of age	0 (0%)	93 (16%)	93 (12.6%)
Sex at Birth			
Female	68 (44%)	333 (57%)	401 (54%)
Male	85 (56%)	255 (43%)	340 (46%)
Ethnicity			
Hispanic/Latino	53 (35%)	155 (26%)	208 (28%)
Not Hispanic/Latino	100 (65%)	433 (74%)	533 (72%)
Race			
Black or African American	4 (2.6%)	67 (11.4%)	71 (9.6%)
Asian	89 (58%)	197 (34%)	286 (38.6%)
White	3 (2%)	155 (26.4%)	158 (21.3%)
Other	4 (2.6%)	14 (2.4%)	18 (2.4%)

Table 2. COVID-19 result of the Flowflex Plus COVID-19 and Flu A/B Home Test compared to reference RT-PCR Assay

COVID-19 Result of Flowflex Plus COVID-19 and Flu A/B Home Test	RT-PCR for COVID-19		
	Positive	Negative	Total
COVID-19 Positive	164	4	168
COVID-19 Negative	17	551	568
Total	181	555	736*
Positive Percent Agreement (PPA)	90.6% (164/181) (95%CI: 85.4% - 94.4%)		
Negative Percent Agreement (NPA)	99.3% (551/555) (95%CI: 98.2% - 99.8%)		

* 5 samples excluded due to invalid/inconclusive results with comparator methods.

Table 3. COVID-19 Clinical Performance in Subjects on Days Post Symptom Onset

Days Post Symptom Onset	Number of Subject samples tested	Flowflex Plus COVID-19 and Flu A/B Home Test Positives	Comparator Positives	% Positive Rate (by Comparator)	PPA (95%CI)
Day 0	26	4	6	23.08%	66.7% (22.3%, 95.7%)
Day 1	198	39	42	21.21%	92.9% (80.5%, 98.5%)
Day 2	214	47	52	24.30%	90.4% (79.4%, 95.8%)
Day 3	157	50	53	33.76%	94.3% (84.3%, 98.8%)
Day 4	75	16	19	25.33%	84.2% (62.4%, 94.5%)
Day 5	46	4	5	10.87%	80.0% (28.4%, 99.5%)
Day 6*	20	4	4	20.00%	100.0% (51.0%, 100.0%)
Total	736	164	181	24.59%	90.6% (85.5%, 94.1%)

* This stratum contains two SARS-CoV-2 that were positive and four samples that were negative by the comparator because the sample number for DPSO 7 was too low to generate a sufficiently robust point estimate to support inclusion of DPSO 7 into the intended use.

Table 4. Flu A results of Flowflex Plus COVID-19 and Flu A/B Home Test compared to reference RT-PCR Assay

Flu A Result of Flowflex Plus COVID-19 and Flu A/B Home Test	RT-PCR for Flu A		
	Positive	Negative	Total
Flu A Positive	77	1	78
Flu A Negative	7	656	663
Total	84	657	741
Positive Percent Agreement (PPA)	91.7% (77/84) (95%CI: 83.6% - 96.6%)		
Negative Percent Agreement (NPA)	99.8% (656/657) (95%CI: 99.2% - 100%)		

Table 5. Flu B results of Flowflex Plus COVID-19 and Flu A/B Home Test compared to reference RT-PCR Assay

Flu B Result of Flowflex Plus COVID-19 and Flu A/B Home Test	RT-PCR for Flu B		
	Positive	Negative	Total
Flu B Positive	44	2	46
Flu B Negative	3	692	695
Total	47	694	741
Positive Percent Agreement (PPA)	93.6% (44/47) (95%CI: 82.5% - 98.7%)		
Negative Percent Agreement (NPA)	99.7% (692/694) (95%CI: 99.0% - 100%)		

Serial Testing

A prospective clinical study was conducted between January 2021 and May 2023 as a component of the Rapid Acceleration of Diagnostics (RADx) initiative from the National Institutes of Health (NIH). A total of 7,361 individuals were enrolled via a decentralized clinical study design, with a broad geographical representation of the United States. Per inclusion criteria, all individuals were asymptomatic upon enrollment in the study and at least 14 days prior to it and did not have a SARS-CoV-2 infection in the three months prior to enrollment. Participants were assigned to one of three EUA authorized SARS-CoV-2 OTC rapid antigen tests to conduct serial testing (every 48 hours) for 15 days. If an antigen test was positive, the serial-antigen testing result is considered positive.

At each rapid antigen testing time point, study subjects also collected a nasal swab for comparator testing using a home collection kit (using a 15-minute normalization window between swabs). SARS-CoV-2 infection status was determined by a composite comparator method on the day of the first antigen test, using at least two highly sensitive EUA RT-PCRs. If results of the first two molecular tests were discordant a third highly sensitive EUA RT-PCR test was performed, and the final test result was based upon the majority rule.

Study participants reported symptom status throughout the study using the MyDataHelps app. Two-day serial antigen testing is defined as performing two antigen tests 36 - 48 hours apart. Three-day serial antigen testing is defined as performing three antigen tests over five days with at least 48 hours between each test.

Out of the 7,361 participants enrolled in the study, 5,609 were eligible for analysis. Among eligible participants, 154 tested positive for SARS-CoV-2 infection based on RT-PCR, of which 97 (62%) were asymptomatic on the first day of their infection, whereas 57 (39%) reported symptoms on the first day of infection.

Performance of the antigen test with serial testing in symptomatic individuals is described in the table below.

Data establishing PPA of COVID-19 antigen serial testing compared to the molecular comparator single day testing throughout the course of infection with serial testing. Data is from all antigen tests in the study combined.

DAYS AFTER FIRST PCR POSITIVE TEST RESULT	SYMPTOMATIC ON FIRST DAY OF TESTING		
	Ag Positive / PCR Positive (Antigen Test Performance % PPA)		
	1 Test	2 Tests	3 Tests
0	34/57 (59.6%)	47/51 (92.2%)	44/47 (93.6%)
2	58/62 (93.5%)	59/60 (98.3%)	43/43 (100%)
4	55/58 (94.8%)	53/54 (98.1%)	39/40 (97.5%)
6	27/34 (79.4%)	26/33 (78.8%)	22/27 (81.5%)
8	12/17 (70.6%)	12/17 (70.6%)	7/11 (63.6%)
10	4/9 (44.4%)	3/7 (42.9%)	

1 Test = one (1) test performed on the noted days after first PCR positive test result. Day 0 is the first day of documented infection with SARS-CoV-2.

2 Tests = two (2) tests performed an average of 48 hours apart. The first test performed on the indicated day and the second test performed 48 hours later.

3 Tests = three (3) tests performance an average of 48 hours apart. The first test performed on the indicated day, the second test performed 48 hours later, and a final test performed 48 hours after the second test

Usability Study

A total of 741 subjects were enrolled in the usability study for the Flowflex Plus COVID-19 and Flu A/B Home Test. The subjects were instructed to self-collect or collect a sample from a child, complete the required procedural steps, and interpret the test results unassisted in a simulated home-setting. The overall success of every task completed by all subjects enrolled was determined by the observation of unassisted professionals and the results were acceptable.

Analytical Sensitivity: Limit of Detection (LoD)

The Limit of Detection (LoD) of the Flowflex Plus COVID-19 and Flu A/B Home Test was determined using limiting dilutions of heat-inactivated SARS-CoV-2 virus and two strains each of live Flu A and Flu B viruses. LoD was determined as the lowest virus concentration that was detected $\geq 95\%$ of the time.

Nasal swabs from healthy donors were collected. Each collected swab was eluted with 350 μ L of PBS. The swab eluates were combined and mixed thoroughly to create a negative pooled nasal swab matrix (PNSM). SARS-CoV-2 virus and Flu A/B virus were diluted in PNSM to generate virus dilutions for testing.

Contrived nasal swab samples were prepared by applying 50 µL of each virus dilution onto the swab. The swab samples were processed and tested according to the package insert. Range-finding testing was conducted with five replicates at various dilutions and confirmatory testing was conducted with 20 replicates for each of three device lots.

Table 6. LoD of Flowflex Plus COVID-19 and Flu A/B Home Test

Virus	Subtype/ Lineage	LoD concentration (TCID ₅₀ /mL)	LoD concentration (TCID ₅₀ /swab)	# Positive /# Total	Percent Detected (%)
Flu A/Brisbane/02/18	H1N1	1.51 x 10 ³	7.55 x 10 ¹	60/60	100%
Flu A/Perth/16/09	H3N2	1.87 x 10 ³	9.35 x 10 ¹	60/60	100%
Flu B/Washington/02/19	Victoria	5.17 x 10 ⁰	0.259	60/60	100%
Flu B/Phuket/3073/13	Yamagata	1.86 x 10 ¹	0.93	60/60	100%
SARS-COV-2	USA- WA1/2020	1.27 x 10 ³	6.35 x 10 ¹	60/60	100%

Based on this testing, the LoD of Flowflex Plus COVID-19 and Flu A/B Home Test was confirmed as 1.27 x 10³ TCID₅₀/mL for COVID-19 (SARS-COV-2 USA-WA1/2020), 1.51 x 10³ TCID₅₀/mL for Flu A H1N1, 1.87 x 10³ TCID₅₀/mL for Flu A H3N2, 5.17 x 10⁰ TCID₅₀/mL for Flu B (Victoria), and 1.86 x 10¹ TCID₅₀/mL for Flu B (Yamagata) in PNSM.

The analytical sensitivity of the Flowflex Plus COVID-19 and Flu A/B Home Test was also determined using limiting dilutions of the 1st WHO International Standard for SARS-CoV-2 antigen (NIBSC code: 21/368) containing SARS-CoV-2 Omicron (B.1.1.529, sub-variant BA.1).

The WHO International Standard for SARS-CoV-2 antigen was diluted in PNSM to generate virus dilutions for testing. Contrived nasal swab samples were prepared by applying 50 µL of each virus dilution onto the swab. The swab samples were processed and tested according to the package insert. The analytical sensitivity was confirmed with 20 replicates for each of three device lots.

Table 7. Analytical Sensitivity of COVID-19 test with WHO International Standard SARS-CoV-2

WHO International Standard SARS-CoV-2 Concentration	# Positives/# Total	Percent Detected (%)
2.00 x 10 ² IU/mL	60/60	100%

The analytical sensitivity of the Flowflex Plus COVID-19 and Flu A/B Home Test with the WHO International Standard for SARS-CoV-2 antigen was confirmed as 200 IU/mL (10 IU/swab) in PNSM.

Multi-lot Precision Study

Three lots of the Flowflex Plus COVID-19 and Flu A/B Home Test were evaluated for precision with more than 500 test kits results in ten non-consecutive days. The test sample panels consisted of three samples at negative, low positive (1.5 x LoD) and positive (5 x LoD). The sample panel was tested in a blinded manner by three operators for ten non-consecutive days. The results showed 100% expected results across all lots, operators, and days. No variability was observed between the three independently manufactured device lots.

Analytical Reactivity Study

Analytical reactivity study was conducted using contrived samples prepared by spiking various strains of SARS-CoV-2 virus, Flu A virus or Flu B viruses into pooled nasal swab matrix (PNSM) in a series of ten-fold dilution and three-fold dilutions tested in five replicates per the Quick Reference Instructions. Concentrations listed in the table below indicate the lowest detectable concentrations for which all 5 replicates were positive.

Table 8. Summary of SARS-Cov-2 Analytical Reactivity with Flowflex Plus COVID-19 and Flu A/B Home Test

Type	Subtype/ Lineage	Virus Strain	Flowflex Plus COVID-19 and Flu A/B Home Test	
			Analytical reactivity (TCID ₅₀ /mL)	Positive rate (COVID-19)
SARS-Cov-2	B1.1.529, Omicron	SARS-Cov-2 (B.1.1.529 Omicron) USA/MD-HP20874/2021	5.01 x 10 ²	100%
	B.1.17, Alpha	SARS-Cov-2 (B.1.1.7 Alpha)	4.20 x 10 ²	100%
	B.1.351, South Africa	SARS-Cov-2 (B.1.351 South Africa)	1.05 x 10 ³	100%
	B.1.617.2 Delta	SARS-Cov-2 (B.1.617.2 Delta)	1.05 x 10 ³	100%
	BA. 2.3, Omicron	SARS-Cov-2 (BA.2.3 Omicron)	7.34 x 10 ²	100%
	Brazil, P.1	SARS-Cov-2 (Brazil P.1)	1.26 x 10 ³	100%
	B.1.1.529, Omicron	USA/CO-CDPHE-2102544747/2021	4.17 x 10 ²	100%
	BA.2.12.1, Omicron	USA/NY-Wadsworth-22014351-01/2022	1.26 x 10 ³	100%
	BA.2.75.5, Omicron	USA/NY-Wadsworth-22037154-01/2022	1.70 x 10 ²	100%
	BA.4.6, Omicron	USA/MD-HP35538/2022	1.15 x 10 ³	100%
	BA.5, Omicron	USA/COR-22-063113/2022	2.53 x 10 ³	100%
	BA.5.5, Omicron	USA/NY-Wadsworth-22023478-01/2022	1.56 x 10 ²	100%
	BF.5, Omicron	USA/MD-HP34985/2022	2.93 x 10 ³	100%

	BF.7, Omicron	USA/NY-Wadsworth-22042128-01/2022	1.26 x 10 ³	100%
	BQ.1, Omicron	USA/NY-Wadsworth-22050462-01/2022	1.43 x 10 ³	100%
	BQ.1.1, Omicron	USA/MD-HP38861/2022	2.93 x 10 ²	100%
	BQ.1.16, Omicron	USA/NY-Wadsworth-22050865-01/2022	2.19 x 10 ³	100%
	BQ.1.3, Omicron	USA/NY-Wadsworth-22047869-01/2022	3.20 x 10 ³	100%
	XBB, Omicron	USA/CA-Stanford-109_S21/2022	1.98 x 10 ⁴	100%

Table 9. Summary of Flu A Analytical Reactivity with Flowflex Plus COVID-19 and Flu A/B Home Test

Type	Subtype/ Lineage	Virus Strain	Flowflex Plus COVID-19 and Flu A/B Home Test	
			Analytical Reactivity (TCID ₅₀ /mL)	Positive rate (Flu A)
Influenza A	H1N1	A/California/07/09	1.38 x 10 ⁴	100%
		A/Guangdong Maonan/SWL/1536/19	1.39 x 10 ⁴	100%
		A/Kumamoto/102/02	1.05 x 10 ⁴	100%
		A/Mexico/4108/09 (pdm)	2.41 x 10 ³	100%
		A/Michigan/45/15	6.20 x 10 ²	100%
		A/New Caledonia/20/99	1.67 x 10 ³	100%
		A/New York/18/09 (pdm)	1.41 x 10 ²	100%
		A/Puerto Rico/8/34	1.67 x 10 ³	100%
		A/Solomon Islands/03/06	5.62 x 10 ¹	100%
		A/Taiwan/42/06	4.57 x 10 ³	100%
	H3N2	A/Brisbane/10/07	4.17 x 10 ²	100%
		A/Hong Kong/2671/19	5.67 x 10 ²	100%
		A/Kansas/14/17	3.80 x 10 ³	100%
		A/Norway/466/14	1.23 x 10 ⁴	100%
		A/Singapore/INFIMH-16-0019/16	1.67 x 10 ³	100%
		A/Texas/50/12	1.18 x 10 ³	100%
		A/Victoria/361/11	1.80 x 10 ³	100%
A/Wisconsin/67/05	4.70 x 10 ²	100%		

Table 10. Summary of Flu B Analytical Reactivity with Flowflex Plus COVID-19 and Flu A/B Home Test

Type	Subtype/ Lineage	Virus Strain	Flowflex Plus COVID-19 and Flu A/B Home Test	
			Analytical Reactivity (TCID ₅₀ /mL)	Positive rate (Flu B)
Influenza B	Victoria	B/Alabama/2/17	1.39 x 10 ²	100%
		B/Lee/40	1.26 x 10 ³	100%
		B/Malaysia/2506/04	1.27 x 10 ³	100%
	Yamagata	B/Panama/45/90	3.80 x 10 ³	100%
		B/Florida/02/06	4.70 x 10 ¹	100%
		B/Florida/04/06	3.55 x 10 ¹	100%
		B/Massachusetts/2/12	4.20 x 10 ²	100%
		B/Texas/6/11	2.41 x 10 ²	100%
		B/Utah/9/14	1.27 x 10 ³	100%
		B/Victoria/504/00	4.20 x 10 ²	100%
		B/Wisconsin/1/10	1.87 x 10 ¹	100%
B/Yamagata/16/88	4.70 x 10 ¹	100%		

Analytical Specificity: Cross-Reactivity and Microbial Interference

Cross-reactivity and Microbial interference were evaluated by testing a panel of related viruses, high prevalence disease agents, and normal or pathogenic flora that are reasonably likely to be encountered in nasal swab specimens. Each microorganism was tested in the absence or presence of SARS-CoV-2 virus (USA-WA1/2020), Influenza A H1N1 virus (Strain: Brisbane/02/18) and Influenza B virus (Washington/02/19) at a low concentration (3 x LoD) in triplicate.

No cross-reactivity or interference was observed with the following microorganisms when tested at the concentration presented in the table below.

Table 11. Summary of analytical specificity of Flowflex Plus COVID-19 and Flu A/B Home Test

Microorganism	Concentration of microorganism applied to dry swab	Cross-reactivity Results	Interference Results
Adenovirus Type 1	2.82 x 10 ⁶ TCID ₅₀ /mL	No cross-reactivity	No Interference
Adenovirus Type 7	1.15 x 10 ⁶ TCID ₅₀ /mL	No cross-reactivity	No Interference
Bordetella pertussis	1.16 x 10 ⁹ CFU/mL	No cross-reactivity	No Interference
Candida albicans	1.31 x 10 ⁷ CFU/mL	No cross-reactivity	No Interference

Chlamydia pneumonia	1.4 x 10 ⁷ IFU/mL	No cross-reactivity	No Interference
Chlamydia trachomatis	3.52 x 10 ⁸ IFU/mL	No cross-reactivity	No Interference
Corynebacterium jeikeium	5.18 x 10 ⁷ CFU/mL	No cross-reactivity	No Interference
Cytomegalovirus	1.00 x 10 ⁵ TCID ₅₀ /mL	No cross-reactivity	No Interference
Enterovirus	1.95 x 10 ⁴ TCID ₅₀ /mL	No cross-reactivity	No Interference
Epstein-Barr Virus	2.94 x 10 ⁶ cp/mL	No cross-reactivity	No Interference
Escherichia coli	7.17 x 10 ⁸ CFU/mL	No cross-reactivity	No Interference
Haemophilus influenzae	3.87 x 10 ⁷ CFU/mL	No cross-reactivity	No Interference
Human coronavirus 229E	2.09 x 10 ⁵ TCID ₅₀ /mL	No cross-reactivity	No Interference
Human coronavirus HKU1 specimen	Ct 13.7 - Ct 19.8	No cross-reactivity	No Interference
Human coronavirus NL63	1.78 x 10 ⁵ TCID ₅₀ /mL	No cross-reactivity	No Interference
Human coronavirus OC43	2.09 x 10 ⁵ TCID ₅₀ /mL	No cross-reactivity	No Interference
Human Metapneumovirus	3.80 x 10 ⁵ TCID ₅₀ /mL	No cross-reactivity	No Interference
Lactobacillus salivarius	5.15 x 10 ⁸ CFU/mL	No cross-reactivity	No Interference
Legionella pneumophila	3.27 x 10 ⁹ CFU/mL	No cross-reactivity	No Interference
Measles Virus	1.23 x 10 ⁷ TCID ₅₀ /mL	No cross-reactivity	No Interference
MERS-coronavirus	1.05 x 10 ⁵ TCID ₅₀ /mL	No cross-reactivity	No Interference
Moraxella catarrhalis	5.92 x 10 ⁷ CFU/mL	No cross-reactivity	No Interference
Mumps Virus	4.78 x 10 ⁶ TCID ₅₀ /mL	No cross-reactivity	No Interference
Mycobacterium tuberculosis	1.21 x 10 ⁷ CFU/mL	No cross-reactivity	No Interference
Mycoplasma pneumoniae	2.70 x 10 ⁷ CCU/mL	No cross-reactivity	No Interference
Neisseria meningitidis	2.04 x 10 ⁷ CFU/mL	No cross-reactivity	No Interference
Neisseria mucosa	1.49 x 10 ⁸ CFU/mL	No cross-reactivity	No Interference
Neisseria sicca	9.55 x 10 ⁸ CFU/mL	No cross-reactivity	No Interference
Parainfluenza virus 1	3.80 x 10 ⁵ TCID ₅₀ /mL	No cross-reactivity	No Interference
Parainfluenza virus 2	3.39 x 10 ⁶ TCID ₅₀ /mL	No cross-reactivity	No Interference
Parainfluenza virus 3	1.15 x 10 ⁶ TCID ₅₀ /mL	No cross-reactivity	No Interference
Parainfluenza virus 4	9.55 x 10 ⁵ TCID ₅₀ /mL	No cross-reactivity	No Interference
Pooled human nasal cavity wash	n/a	No cross-reactivity	No Interference
Pseudomonas aeruginosa	4.93 x 10 ⁸ CFU/mL	No cross-reactivity	No Interference
Respiratory syncytial virus	2.09 x 10 ⁵ TCID ₅₀ /mL	No cross-reactivity	No Interference
Rhinovirus	1.00 x 10 ⁵ TCID ₅₀ /mL	No cross-reactivity	No Interference
Staphylococcus aureus	9.23 x 10 ⁸ CFU/mL	No cross-reactivity	No Interference
Staphylococcus epidermidis	6.84 x 10 ⁸ CFU/mL	No cross-reactivity	No Interference

Streptococcus pneumoniae	7.22 x 10 ⁷ CFU/mL	No cross-reactivity	No Interference
Streptococcus pyogenes	4.60 x 10 ⁸ CFU/mL	No cross-reactivity	No Interference
Streptococcus salivarius	1.35 x 10 ⁸ CFU/mL	No cross-reactivity	No Interference

The sequence homology was compared between the SARS-CoV-2 nucleocapsid protein and the structural proteins of SARS coronavirus (SARS-CoV) and with given the substantial homology rate (91.5%), there is high probability of cross-reactivity between the nucleocapsid proteins of SARS-CoV-2 and SARS-CoV. The Flowflex Plus COVID-19 and Flu A/B Home Test does not differentiate between SARS-CoV and SARS-CoV-2.

Endogenous and Exogenous Interference Substances

The following medically relevant endogenous and exogenous interferents that may be encountered in the collected samples from the upper respiratory tract were evaluated. Substances that are commonly found on the hands were also tested. Each substance was tested in triplicate in the absence or presence of SARS-CoV-2 virus (USA-WA1/2020), Influenza A H1N1 virus (Strain: Brisbane/02/18) and Influenza B virus (Washington/02/19) at a low concentration (3 x LoD). The performance of Flowflex Plus COVID-19 and Flu A/B Home Test was not affected by any of the interference substances tested at the concentration listed in the table below.

Table 12. Summary of interference substance study on Flowflex Plus COVID-19 and Flu A/B Home Test

Interfering Substance	Conc. of Interfering Substance applied to dry swab	Cross-reactivity Results	Interference Results
Beclomethasone	5 mg/mL	No cross-reactivity	No interference
Biotin	3500 ng/mL	No cross-reactivity	No interference
Dexamethasone	5 mg/mL	No cross-reactivity	No interference
Dyclonine Hydrochloride	1.5 mg/mL	No cross-reactivity	No interference
Flunisolide	5 mg/mL	No cross-reactivity	No interference
Hand sanitizer	15% v/v	No cross-reactivity	No interference
Hand Soap	15% v/v	No cross-reactivity	No interference
Homeopathic Allergy Relief medicine (histaminum hydrochloricum)	15% w/v	No cross-reactivity	No interference
Homeopathic nasal wash	15% v/v	No cross-reactivity	No interference
Leukocytes	4.8 x 10 ⁶ cells/mL	No cross-reactivity	No interference
Molnupiravir	10 mg/mL	No cross-reactivity	No interference
Mucin	2.5 mg/mL	No cross-reactivity	No interference
Mupirocin	10 mg/mL	No cross-reactivity	No interference
Nasal corticosteroids (Budesonide)	15% v/v	No cross-reactivity	No interference

Nasal corticosteroids (fluticasone furate)	5% v/v	No cross-reactivity	No interference
Nasal corticosteroids (fluticasone propionate)	5% v/v	No cross-reactivity	No interference
Nasal corticosteroids (Mometasone furoate)	15% v/v	No cross-reactivity	No interference
Nasal corticosteroids (Triamcinolone Acetonide)	15% v/v	No cross-reactivity	No interference
Nasal gel	15% v/v	No cross-reactivity	No interference
Nasal Spray (Cromolyn Sodium)	15% v/v	No cross-reactivity	No interference
Nasal Spray (Oxymetazoline HCl)	15% v/v	No cross-reactivity	No interference
Nasal Spray (Phenylephrine HCl)	15% v/v	No cross-reactivity	No interference
Nasal Wash (Saline nasal wash: sodium chloride & preservatives)	15% v/v	No cross-reactivity	No interference
Oral Anesthetic Cough Lozenge (Menthol)	3 mg/mL	No cross-reactivity	No interference
Oseltamivir Phosphate	5% w/v	No cross-reactivity	No interference
Remdesivir	10 mg/mL	No cross-reactivity	No interference
Sore Throat & Cough Lozenges (Benzocaine, Dextromethorphan HBr)	3 mg/mL	No cross-reactivity	No interference
Sore Throat Spray (Phenol)	5% w/v	No cross-reactivity	No interference
Tobramycin	50 µg/mL	No cross-reactivity	No interference
Whole Blood	2.5%	No cross-reactivity	No interference
Zanamivir	5 mg/mL	No cross-reactivity	No interference
ZICAM Nasal Decongestant, Cold Remedy Nasal Spray (Galphimia glauca, Luffa operculata, Sabadilla)	15% v/v	No cross-reactivity	No interference

High Dose Hook Effect

No high dose hook effect was observed on the Flowflex Plus COVID-19 and Flu A/B Home Test when tested with SARS-CoV-2 virus at a concentration of 3.80×10^6 TCID₅₀/mL, Flu A virus at a concentration of 1.51×10^6 TCID₅₀/mL, or Flu B virus at a concentration of 1.55×10^4 TCID₅₀/mL, respectively.

Competitive Interference

For co-infection, ~ 2 x LoD influenza A and/or influenza B were tested in the presence of high levels of SARS-CoV-2; and ~ 2 x LoD SARS-CoV-2 was tested in triplicate in the presence of high levels of influenza A and/or influenza B. No competitive interference was observed between SARS-CoV-2 and influenza A and B as listed in the Table below.











Table 13. Results of Competitive Interference

Assigned Sample Panel #	High concentration analyte		Low concentration analyte		Low concentration analyte Percent Positivity
	Virus	Spiked Concentration (TCID ₅₀ /mL)	Virus	Concentration 2xLoD (TCID ₅₀ /mL)	
1	Flu A/ Brisbane/02/18 (H1N1)	1.12 x 10 ⁵	Flu B/ Washington/02/19 (Victoria)	1.03 x 10	100%
2	Flu A/ Brisbane/02/18 (H1N1)	1.12 x 10 ⁵	SARS-COV-2 (USA-WA1/2020)	2.53 x 10 ³	100%
3	Flu B/ Washington/02/19 (Victoria)	1.00 x 10 ⁴	Flu A/ Brisbane/02/18 (H1N1)	3.02 x 10 ³	100%
4	Flu B/ Washington/02/19 (Victoria)	1.00 x 10 ⁴	SARS-COV-2 (USA-WA1/2020)	2.53 x 10 ³	100%
5	SARS-COV-2 (USA-WA1/2020)	1.41 x 10 ⁵	Flu A/ Brisbane/02/18 (H1N1)	3.02 x 10 ³	100%
6	SARS-COV-2 (USA-WA1/2020)	1.41 x 10 ⁵	Flu B/ Washington/02/19 (Victoria)	1.03 x 10	100%
7	Flu A/ Brisbane/02/18 (H1N1)	1.51 x 10 ⁶	Flu B/ Washington/02/19 (Victoria)	1.03 x 10	100%
			SARS-COV-2 (USA-WA1/2020)	2.53 x 10 ³	100%
8	Flu B/ Washington/02/19 (Victoria)	1.00 x 10 ⁴	Flu A/ Brisbane/02/18 (H1N1)	3.02 x 10 ³	100%
			SARS-COV-2 (USA-WA1/2020)	2.53 x 10 ³	100%
9	SARS-COV-2 (USA-WA1/2020)	1.41 x 10 ⁵	Flu A/ Brisbane/02/18 (H1N1)	3.02 x 10 ³	100%
			Flu B/ Washington/02/19 (Victoria)	1.03 x 10	100%

BIBLIOGRAPHY

1. Shuo Su, Gary Wong, Weifeng Shi, et al. Epidemiology, Genetic recombination, and pathogenesis of coronaviruses. Trends in Microbiology, June 2016, vol. 24, No. 6: 490-502
2. Susan R. Weiss, Julian L. Leibowitz, Coronavirus Pathogenesis, Advances in Virus Research, Volume 81: 85-164

Index of Symbols

	Manufacturer		Date of manufacture
	Contains sufficient for $\langle n \rangle$ tests		Catalogue number
	<i>In vitro</i> diagnostic medical device		Use-by date
	Consult instructions for use		Batch code
	Temperature limit		Do not reuse

ACON Laboratories, Inc.
 5850 Oberlin Drive, #340
 San Diego, CA 92121, USA
flowflexcovid.com
 Customer Support: 1-800-838-9502

Number: 1151616101
 Effective Date: 2024-07-26