

Medication Guide

Foradil® [FOR-a-dil] Certihaler® (formoterol fumarate inhalation powder)

Read the Medication Guide that comes with FORADIL CERTIHALER before you start using it and each time you get a refill. There may be new information. This Medication Guide does not take the place of talking to your health care provider about your medical condition or treatment.

What is the most important information I should know about FORADIL CERTIHALER?

FORADIL CERTIHALER can cause serious side effects, including:

- 1. People with asthma who take long-acting beta₂-adrenergic agonist (LABA) medicines such as formoterol fumarate inhalation powder (FORADIL CERTIHALER), have an increased risk of death from asthma problems.**
 - Call your healthcare provider if breathing problems worsen over time while using FORADIL CERTIHALER. You may need a different treatment.
 - Get emergency medical care if:
 - breathing problems worsen quickly, and
 - you use your rescue inhaler medicine, but it does not relieve your breathing problems.
- 2. Do not use FORADIL CERTIHALER as your only asthma medicine. FORADIL CERTIHALER must only be used with a long-term asthma control medicine, such as an inhaled corticosteroid.**
3. When your asthma is well controlled, your healthcare provider may tell you to stop taking FORADIL CERTIHALER. Your healthcare provider will decide if you can stop FORADIL CERTIHALER without loss of asthma control. You will continue taking your long-term asthma control medicine, such as a long-term inhaled corticosteroid.
4. Children and adolescents who take LABA medicines may have an increased risk of being hospitalized for asthma problems.

What is FORADIL CERTIHALER?

FORADIL CERTIHALER is a long-acting beta₂-agonist (LABA). LABA medicines help the muscles around the airways in your lungs stay relaxed to prevent asthma symptoms, such as wheezing and shortness of breath. These symptoms can happen when the muscles around the airways tighten. This

makes it hard to breathe. In severe cases, wheezing can stop your breathing and cause death if not treated right away.

FORADIL CERTIHALER is used with other long-term asthma control medicines, such as an inhaled corticosteroid, in adults and children ages 5 and older:

- to control symptoms of asthma, and
- to prevent symptoms such as wheezing

LABA medicines, such as FORADIL CERTIHALER, increase the risk of death from asthma problems. FORADIL CERTIHALER is not for adults and children with asthma who:

- are well controlled with another long-term asthma control medicine, such as low to medium dose of an inhaled corticosteroid medicine.

Who should not use FORADIL CERTIHALER?

- Do not take FORADIL CERTIHALER to treat your asthma without an asthma control medicine, such as a long-term inhaled corticosteroid.
- If you are allergic to formoterol fumarate or any of the ingredients in FORADIL CERTIHALER. Ask your healthcare provider if you are not sure. See the end of the Medication Guide for a complete list of ingredients in FORADIL CERTIHALER.

What should I tell my healthcare provider before using FORADIL CERTIHALER?

Tell your healthcare provider about all of your health conditions, including if you:

- have heart problems
- have high blood pressure
- have seizures
- have thyroid problems
- have diabetes
- are pregnant or planning to become pregnant. It is not known if FORADIL CERTIHALER may harm your unborn baby.
- are breastfeeding. It is not known if FORADIL CERTIHALER passes into your milk and if it can harm your baby.
- are allergic to FORADIL CERTIHALER, any other medicines, or food products.

FORADIL CERTIHALER contains lactose (milk sugar) and a small amount of milk proteins. It is possible that allergic reactions may happen in patients who have a severe milk protein allergy.

Tell your healthcare provider about all the medicines you take including prescription and non-prescription medicines, vitamins, and herbal supplements. FORADIL CERTIHALER and certain other medicines may interact with each other. This may cause serious side effects.

Know the medicines you take. Keep a list and show it to your healthcare provider and pharmacist each time you get a new medicine.

How do I use the FORADIL CERTIHALER inhaler?

See the step-by-step instructions for using the FORADIL CERTIHALER inhaler at the end of this Medication Guide. Do not use FORADIL unless your healthcare provider has taught you and you understand everything. Ask your healthcare provider or pharmacist if you have any questions.

- Children should use FORADIL CERTIHALER with an adult's help, as instructed by the child's healthcare provider.
- Use FORADIL CERTIHALER exactly as prescribed. **Do not use FORADIL CERTIHALER more often than prescribed.**
- The usual dose is 1 inhalation through the CERTIHALER inhaler 2 times each day (morning and evening). The 2 doses should be about 12 hours apart.
- If you miss a dose of FORADIL CERTIHALER, just skip that dose. Take your next dose at your usual time. Never take 2 doses at one time.
- Do not use a spacer device with FORADIL CERTIHALER.
- Do not breathe into FORADIL CERTIHALER.
- While you are using FORADIL CERTIHALER 2 times each day, do not use other medicines that contain a long-acting beta2-agonist (LABA) for any reason. Ask your healthcare provider or pharmacist for a list of these medicines.
- Do not stop using FORADIL CERTIHALER or any of your asthma medicines unless told to do so by your healthcare provider because your symptoms might get worse. Your healthcare provider will change your medicines as needed.
- FORADIL CERTIHALER does not relieve sudden symptoms. Always have a rescue inhaler medicine with you to treat sudden symptoms. If you do not have an inhaled, short-acting bronchodilator, contact your healthcare provider to have one prescribed for you.

- **Call your healthcare provider or get medical care right away if:**
 - your breathing problems worsen with FORADIL CERTIHALER
 - you need to use your rescue inhaler medicine more often than usual
 - your rescue inhaler medicine does not work as well for you at relieving symptoms
 - you need to use 4 or more inhalations of your rescue inhaler medicine for 2 or more days in a row
 - you use 1 whole canister of your rescue inhaler medicine in 8 weeks time
 - your peak flow meter results decrease. Your healthcare provider will tell you the numbers that are right for you.
 - you have asthma and your symptoms do not improve after using FORADIL CERTIHALER regularly for 1 week.

What are the possible side effects with FORADIL CERTIHALER?

FORADIL CERTIHALER may cause serious side effects, including:

- **See “What is the most important information I should know about FORADIL CERTIHALER?”**
- **Bronchospasm with wheezing or coughing and difficulty breathing**
- **Low blood potassium (which may cause symptoms of muscle spasm, muscle weakness or abnormal heart rhythm)**
- **Fast or irregular heart beat (palpitations)**
- **Serious allergic reactions including rash, hives, swelling of the face, mouth, and tongue, and breathing problems.** Call your healthcare provider or get emergency medical care if you get any symptoms of a serious allergic reaction.

Other possible side effects with FORADIL CERTIHALER include:

- chest pain
- increased blood pressure
- nervousness
- dry mouth
- muscle cramps
- nausea
- dizziness
- tiredness
- high blood sugar
- high blood acid
- trouble sleeping

Common side effects with FORADIL CERTIHALER include:

- headache
- tremor
- cough
- rash

Tell your healthcare provider about any side effect that bothers you or that does not go away.

These are not all the side effects with FORADIL CERTIHALER. Ask your healthcare provider or pharmacist for more information. Call your doctor for medical advice about side effects. You may report side effects to FDA at 1-800-FDA-1088.

How do I store FORADIL CERTIHALER?

- Store FORADIL CERTIHALER at room temperature 59°F to 86°F (15°C to 30°C). Protect FORADIL CERTIHALER from heat and moisture.
- Use FORADIL CERTIHALER before the expiration date. The expiration date is marked on the label on the underside of the inhaler.
- **Keep FORADIL CERTIHALER and all medicines out of the reach of children.**

General Information about FORADIL CERTIHALER

Medicines are sometimes prescribed for purposes other than those listed in a Medication Guide. Do not use FORADIL CERTIHALER for a condition for which it was not prescribed. Do not give FORADIL CERTIHALER to other people, even if they have the same condition. It may harm them.

This Medication Guide summarizes the most important information about FORADIL CERTIHALER. If you would like more information or have any questions about the use of FORADIL CERTIHALER, talk with your healthcare provider. You can ask your healthcare provider or pharmacist for information about FORADIL CERTIHALER that was written for healthcare professionals.

What are the ingredients in FORADIL CERTIHALER?

Active ingredient: formoterol fumarate

Inactive ingredients: lactose (contains milk proteins), magnesium stearate

Instructions for Using FORADIL CERTIHALER

Follow the instructions below for using your FORADIL CERTIHALER. **You will breathe-in (inhale) the medicine from the FORADIL CERTIHALER.** If you have any questions, ask your healthcare provider or pharmacist.

FORADIL CERTIHALER

- Keep your FORADIL CERTIHALER Inhaler dry. Handle with DRY hands.



Note: The rattling sound heard when you move the device is normal.

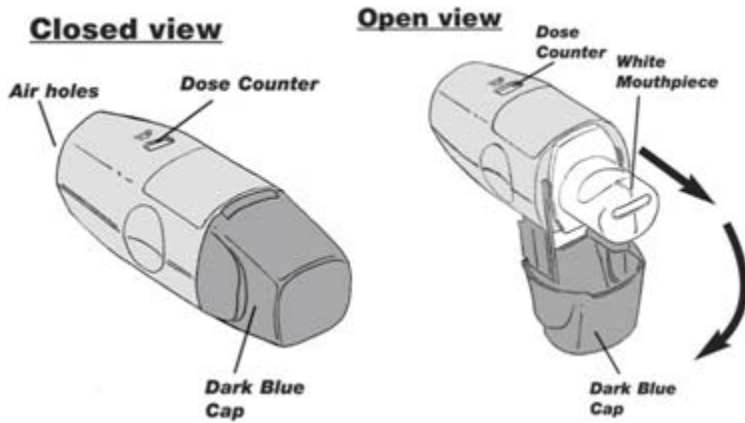

Picture 1

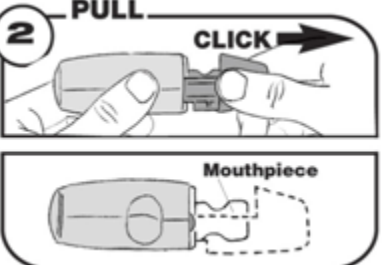
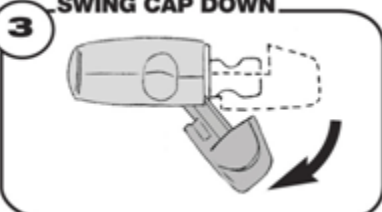

Taking a dose of FORADIL CERTIHALER requires the following steps:

Note the number on the dose counter before you start.

<p>1 MUST HOLD LEVEL</p> 	<p>Hold the inhaler perfectly level with the dose counter facing the ceiling.</p> <hr/> <p>IMPORTANT: The inhaler will not open unless it is level.</p> <hr/> <p>TIP: Place the inhaler on a table or other flat surface while opening to keep level.</p>
<p>2 PULL</p> 	<p>Pull the dark blue cap completely away from the inhaler until you hear a click. (Fully open cap clears mouthpiece.)</p> <p>TIP: If the cap doesn't open fully, reclose it <u>all the way</u> before trying again.</p>
<p>3 SWING CAP DOWN</p> 	<p>Pull cap away from inhaler as you swing down.</p>
<p>4 PUSH FIRMLY UNTIL IT CLICKS & LOCKS</p> 	<p>Push cap firmly until it locks into place with a click.</p> <hr/> <p>IMPORTANT: Cap must click to lock or the inhaler will not work.</p> <hr/> <p>TIP: Pushing hard to lock won't damage the inhaler.</p>

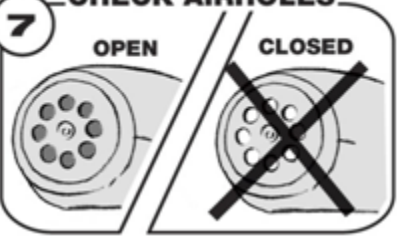
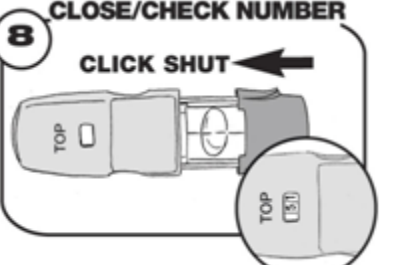
<p>5 EXHALE</p> 	<p>While holding the inhaler level, breathe out (exhale) away from the inhaler, then close your lips firmly over mouthpiece.</p> <p>TIP: Keep fingers clear of air holes at back.</p>
<p>6 TAKE A FAST, DEEP BREATH</p> 	<p>Breathe in (inhale) quickly one fast, deep breath. Hold your breath at least 5 seconds. Exhale away from the inhaler.</p> <hr/> <p>IMPORTANT: If you do not inhale fast enough the inhaler will not work.</p> <hr/> <p>TIP: When you inhale fast and deep enough, you will hear a soft click as the air holes open.</p>
<p>7 CHECK AIRHOLES</p> 	<p>Double-check air holes to see if they opened completely.</p> <hr/> <p>IMPORTANT: If air holes did not open, return to step 4. If the cap was locked down all the way, try inhaling faster and deeper.</p>
<p>8 CLOSE/CHECK NUMBER</p> 	<p>After you have received the dose, close the cap all the way until it clicks shut.</p> <p>The counter will now show you have one less dose left in the inhaler.</p> <p>TIP: Dose counter changes after you close the cap.</p>

IMPORTANT: If the display number did not decrease by one after step 8 above, but you still received your dose of medicine, **stop using the inhaler and contact your pharmacist.** Remember, you will know that you received your dose of medicine, if the ring of air holes was open before you closed the Protective Cap (see step 7 above).

Picture 10

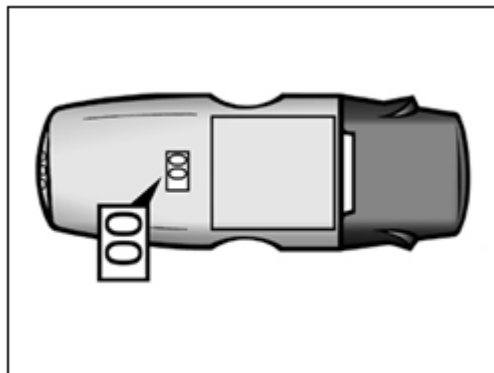

Remember:

- Always keep the Protective Cap closed when you are not using your CERTIHALER unless you are cleaning the mouthpiece.
- Always clean the mouthpiece if the CERTIHALER Inhaler is dropped while the cap is open.
- Always open the CERTIHALER Inhaler in a level, horizontal position, with the counter in the upwards position.
- Make sure that the Protective Cap is clicked into place in its fully open position when inhaling.
- Never breathe into the CERTIHALER Inhaler.
- Never take the CERTIHALER Inhaler apart (aside from removing the mouthpiece for cleaning).
- Never wash the CERTIHALER Inhaler. **Keep it dry.**
- Always keep the CERTIHALER Inhaler in a dry place.

Rx only



Manufactured by*:

SkyePharma Production SAS, Saint Quentin-Fallavier, France

Distributed by:**

Novartis Pharmaceuticals Corp., East Hanover, NJ 07936

* The agreement with SkyePharma has been terminated.

** Since approval, Foradil Certihaler has not been marketed in the United States.

FORADIL is a registered trademark of Astellas Pharma Inc.

CERTIHALER and AEROLIZER are registered trademarks of Novartis AG.

©2010 Novartis Pharmaceuticals Corporation. All rights reserved.

May 2010

XXXXXXX

This Medication Guide has been approved by the U.S. Food and Drug Administration.